

Article number: 20908STM2615A

Description: E+G Threaded plug DIN 908-ST-M26x15-A

Measures

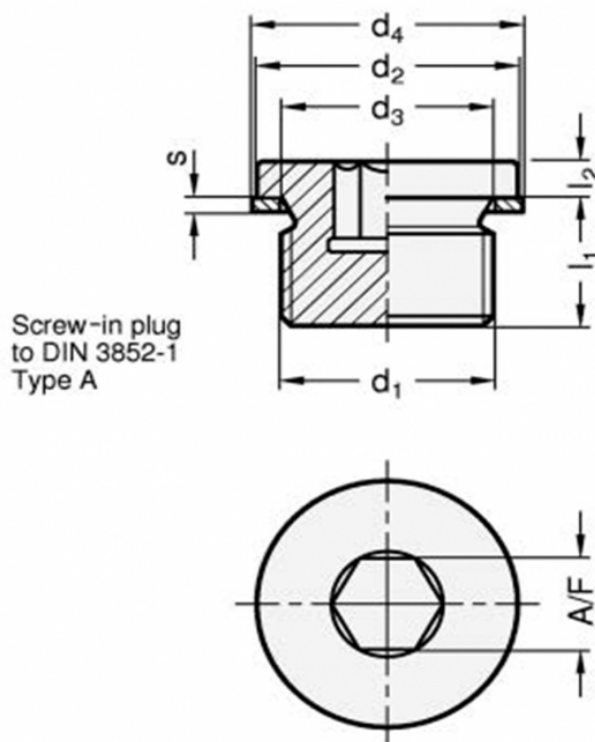

A/F	= 12
d1	= M26x15
d2h14	= 31
d3	= 26.3
d4	= 31
l1	= 16
l2	= 4
s	= 2

Weight in (g) = 73